

- 1. Off White (Mar:1181)
- 2. White (Hat:209)
- 3. Soft Torquoise (Mar:1205)

**Design2.pes**  
4.94x4.45 inches; 29,537 stitches  
3 thread changes; 3 colors



- 1. Off White (Mar:1181)
- 2. Yellow (Isa:310)
- 3. Off White (Mar:1181)
- 4. White (Hat:209)
- 5. Soft Torquoise (Mar:1205)

**Design3-10x10.pes**  
9.65x9.65 inches; 74,213 stitches  
5 thread changes; 4 colors

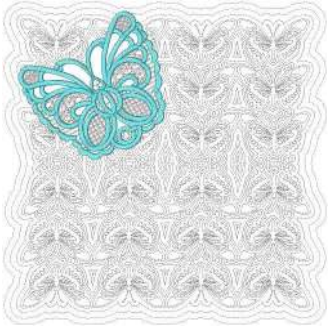

- 1. Off White (Mar:1181)
- 2. Yellow (Isa:310)
- 3. Off White (Mar:1181)
- 4. White (Hat:209)
- 5. Soft Torquoise (Mar:1205)

**Design3-12x12.pes**  
11.61x11.61 inches; 83,962 stitches  
5 thread changes; 4 colors

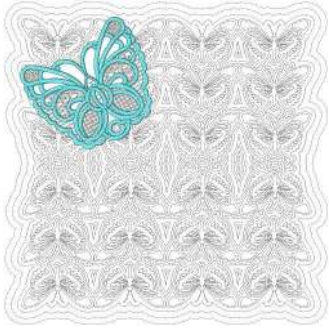

- 1. Off White (Mar:1181)
- 2. Yellow (Isa:310)
- 3. Off White (Mar:1181)
- 4. White (Hat:209)
- 5. Soft Torquoise (Mar:1205)

**Design3-13x13.pes**  
12.99x12.99 inches; 90,422 stitches  
5 thread changes; 4 colors

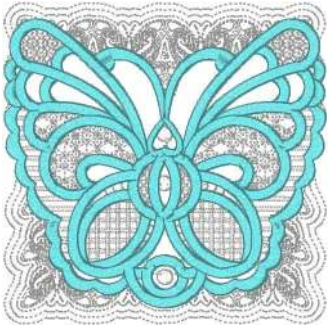

- 1. Off White (Mar:1181)
- 2. Yellow (Isa:310)
- 3. Off White (Mar:1181)
- 4. White (Hat:209)
- 5. Soft Torquoise (Mar:1205)

**Design3-5x5.pes**  
4.94x4.92 inches; 39,899 stitches  
5 thread changes; 4 colors

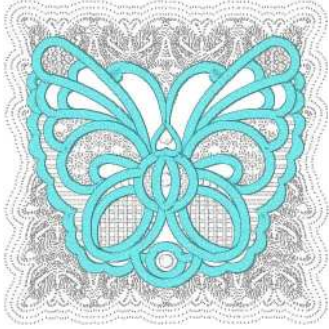

- 1. Off White (Mar:1181)
- 2. Yellow (Isa:310)
- 3. Off White (Mar:1181)
- 4. White (Hat:209)
- 5. Soft Torquoise (Mar:1205)

**Design3-6x6.pes**  
5.71x5.71 inches; 47,084 stitches  
5 thread changes; 4 colors



- 1. Off White (Mar:1181)
- 2. Yellow (Isa:310)
- 3. Off White (Mar:1181)
- 4. White (Hat:209)
- 5. Soft Torquoise (Mar:1205)

**Design3-8x8.pes**  
7.68x7.68 inches; 62,287 stitches  
5 thread changes; 4 colors



- 1. Off White (Mar:1181)
- 2. Yellow (Isa:310)
- 3. Off White (Mar:1181)
- 4. White (Hat:209)
- 5. Soft Torquoise (Mar:1205)

**Design3-9x9.pes**  
8.46x8.46 inches; 67,159 stitches  
5 thread changes; 4 colors

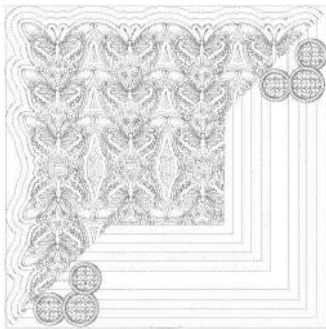

■ 1. Off White (Mar:1181)

**Design4-10x10.pes**  
9.65x9.65 inches; 44,356 stitches  
1 thread changes; 1 colors

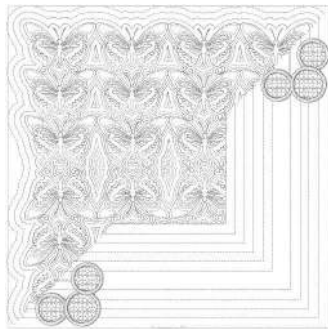

■ 1. Off White (Mar:1181)

**Design4-12x12.pes**  
11.61x11.61 inches; 51,070 stitches  
1 thread changes; 1 colors

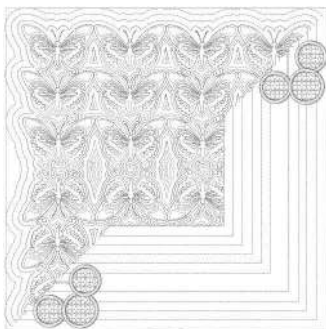

■ 1. Off White (Mar:1181)

**Design4-13x13.pes**  
12.99x12.99 inches; 55,695 stitches  
1 thread changes; 1 colors

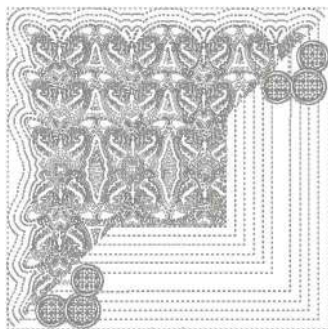

■ 1. Off White (Mar:1181)

**Design4-5x5.pes**  
4.92x4.92 inches; 26,862 stitches  
1 thread changes; 1 colors

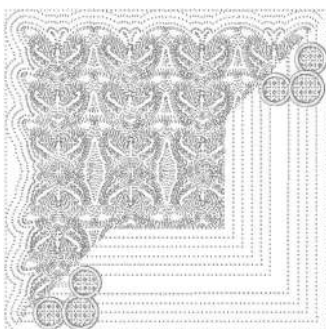

■ 1. Off White (Mar:1181)

**Design4-6x6.pes**  
5.71x5.71 inches; 29,547 stitches  
1 thread changes; 1 colors

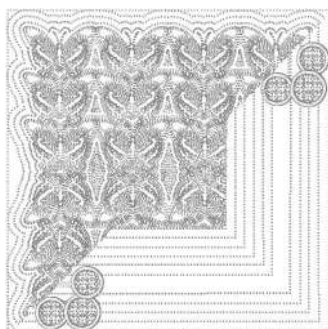

■ 1. Off White (Mar:1181)

**Design4-8x8.pes**  
7.68x7.68 inches; 37,082 stitches  
1 thread changes; 1 colors

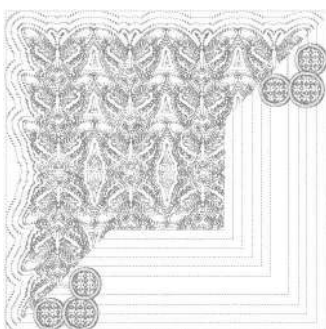

■ 1. Off White (Mar:1181)

**Design4-9x9.pes**  
8.46x8.46 inches; 40,463 stitches  
1 thread changes; 1 colors

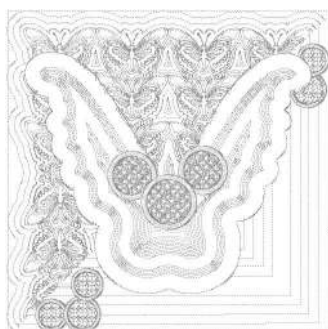

■ 1. Off White (Mar:1181)  
■ 2. Sage Cream (Mar:1182)  
■ 3. Off White (Mar:1181)

**Design5-10x10.pes**  
9.65x9.65 inches; 45,951 stitches  
3 thread changes; 2 colors

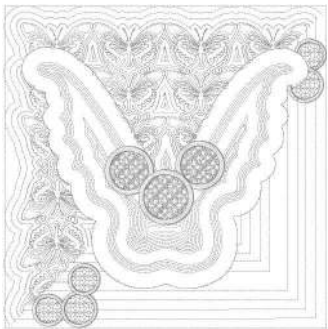

■ 1. Off White (Mar:1181)  
■ 2. Sage Cream (Mar:1182)  
■ 3. Off White (Mar:1181)

**Design5-12x12.pes**  
11.61x11.61 inches; 55,035 stitches  
3 thread changes; 2 colors

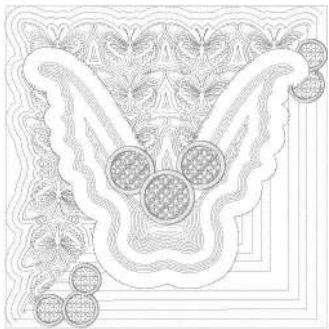

■ 1. Off White (Mar:1181)  
■ 2. Sage Cream (Mar:1182)  
■ 3. Off White (Mar:1181)

**Design5-13x13.pes**  
12.99x12.99 inches; 59,710 stitches  
3 thread changes; 2 colors

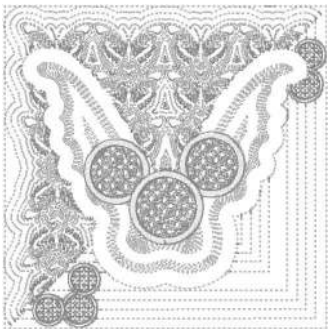

■ 1. Off White (Mar:1181)  
■ 2. Sage Cream (Mar:1182)  
■ 3. Off White (Mar:1181)

**Design5-5x5.pes**  
4.92x4.92 inches; 22,916 stitches  
3 thread changes; 2 colors

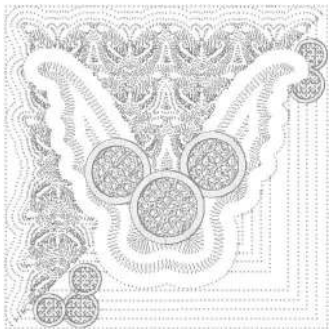

■ 1. Off White (Mar:1181)  
■ 2. Sage Cream (Mar:1182)  
■ 3. Off White (Mar:1181)

**Design5-6x6.pes**  
5.71x5.71 inches; 24,970 stitches  
3 thread changes; 2 colors

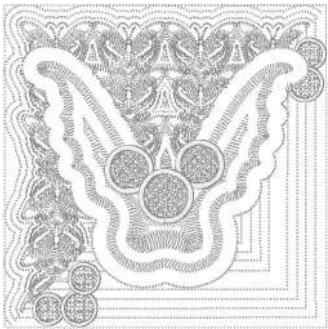

■ 1. Off White (Mar:1181)  
■ 2. Sage Cream (Mar:1182)  
■ 3. Off White (Mar:1181)

**Design5-8x8.pes**  
7.68x7.68 inches; 38,820 stitches  
3 thread changes; 2 colors

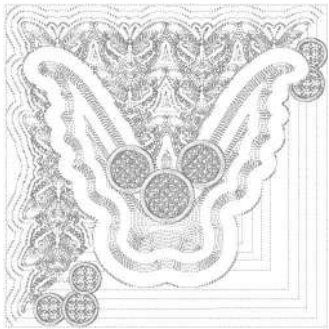

■ 1. Off White (Mar:1181)  
■ 2. Sage Cream (Mar:1182)  
■ 3. Off White (Mar:1181)

**Design5-9x9.pes**  
8.46x8.46 inches; 41,578 stitches  
3 thread changes; 2 colors

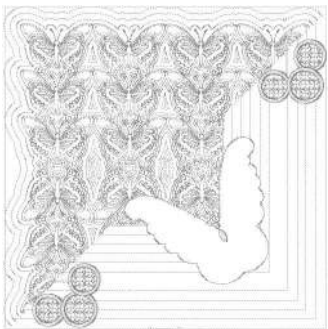

■ 1. Off White (Mar:1181)  
■ 2. Sage Cream (Mar:1182)  
■ 3. Off White (Mar:1181)

**Design6-10x10-3d.pes**  
9.65x9.65 inches; 45,415 stitches  
3 thread changes; 2 colors

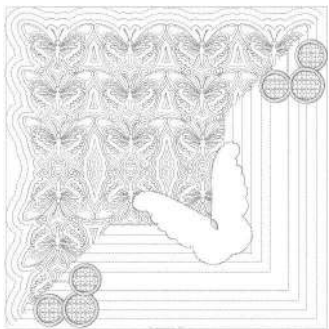

■ 1. Off White (Mar:1181)  
■ 2. Sage Cream (Mar:1182)  
■ 3. Off White (Mar:1181)

**Design6-12x12-3d.pes**  
11.61x11.61 inches; 51,836 stitches  
3 thread changes; 2 colors

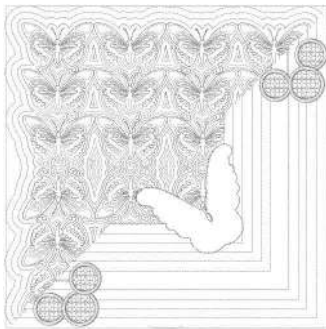

■ 1. Off White (Mar:1181)  
■ 2. Sage Cream (Mar:1182)  
■ 3. Off White (Mar:1181)

**Design6-13x13-3d.pes**  
12.99x12.99 inches; 56,389 stitches  
3 thread changes; 2 colors



■ 1. Off White (Mar:1181)  
■ 2. Sage Cream (Mar:1182)  
■ 3. Off White (Mar:1181)

**Design6-5x5-3d.pes**  
4.92x4.92 inches; 18,835 stitches  
3 thread changes; 2 colors



■ 1. Off White (Mar:1181)  
■ 2. Sage Cream (Mar:1182)  
■ 3. Off White (Mar:1181)

**Design6-6x6-3d.pes**  
5.71x5.71 inches; 20,796 stitches  
3 thread changes; 2 colors

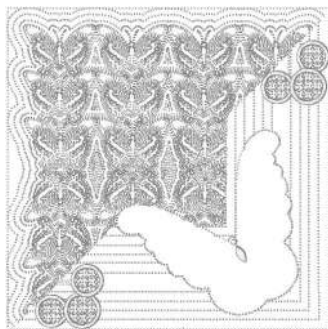

■ 1. Off White (Mar:1181)  
■ 2. Sage Cream (Mar:1182)  
■ 3. Off White (Mar:1181)

**Design6-8x8-3d.pes**  
7.68x7.68 inches; 36,769 stitches  
3 thread changes; 2 colors

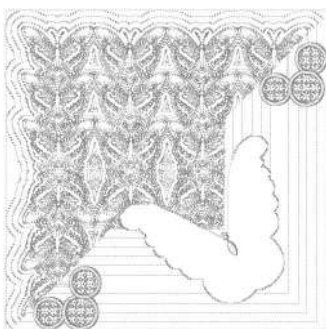

■ 1. Off White (Mar:1181)  
■ 2. Sage Cream (Mar:1182)  
■ 3. Off White (Mar:1181)

**Design6-9x9-3d.pes**  
8.46x8.46 inches; 39,951 stitches  
3 thread changes; 2 colors



■ 1. Off White (Mar:1181)  
■ 2. Soft Torquoise (Mar:1205)

**Design7.pes**  
4.94x4.26 inches; 21,274 stitches  
2 thread changes; 2 colors

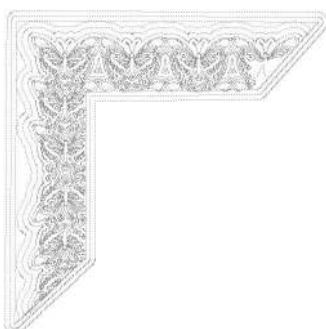

■ 1. Off White (Mar:1181)

**Design8-10x10-Corner.pes**  
9.65x9.65 inches; 19,280 stitches  
1 thread changes; 1 colors

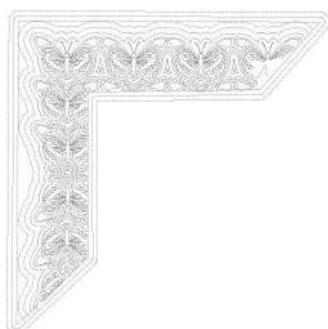

■ 1. Off White (Mar:1181)

**Design8-12x12-Corner.pes**  
11.61x11.61 inches; 22,181 stitches  
1 thread changes; 1 colors

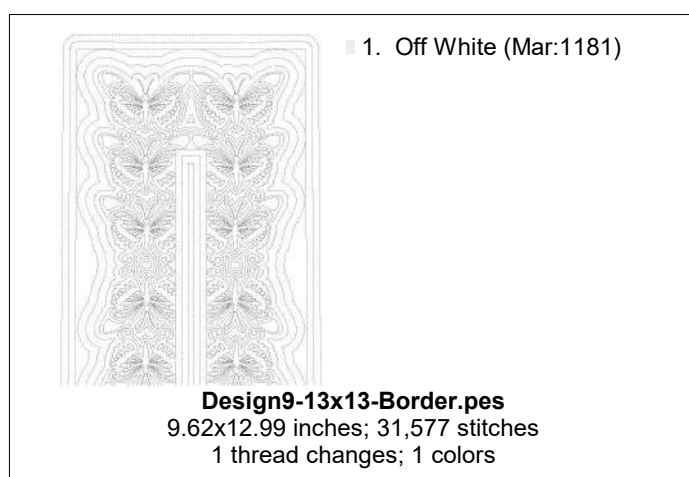
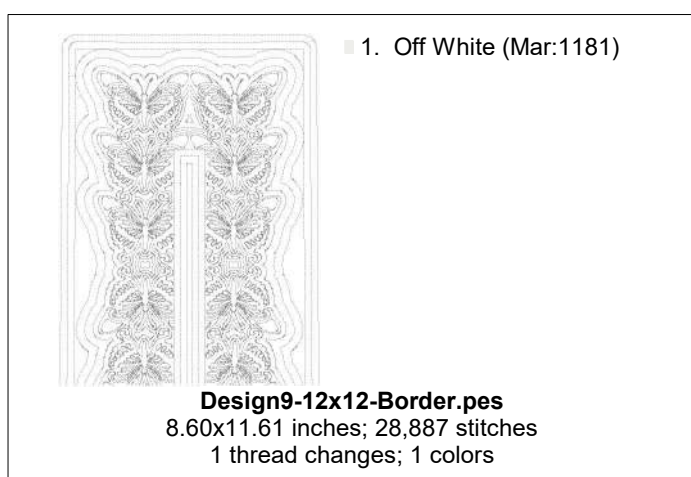
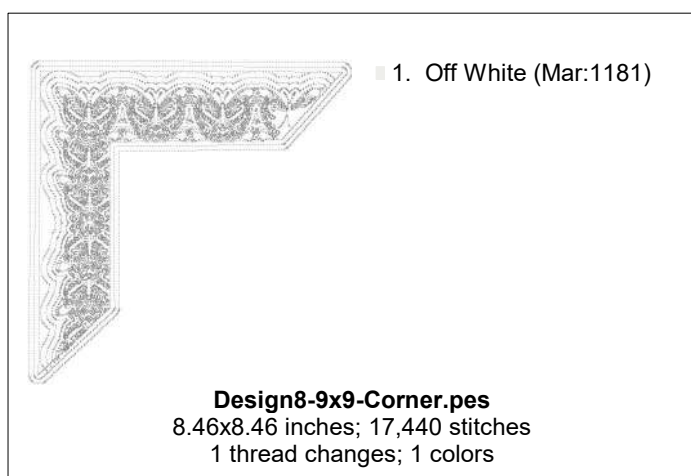
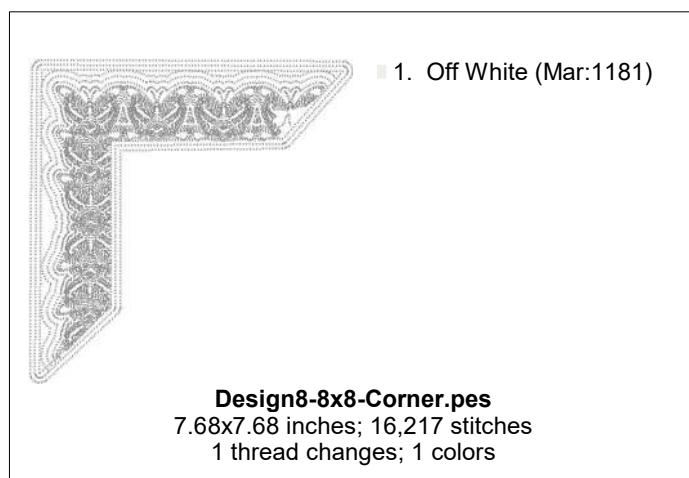
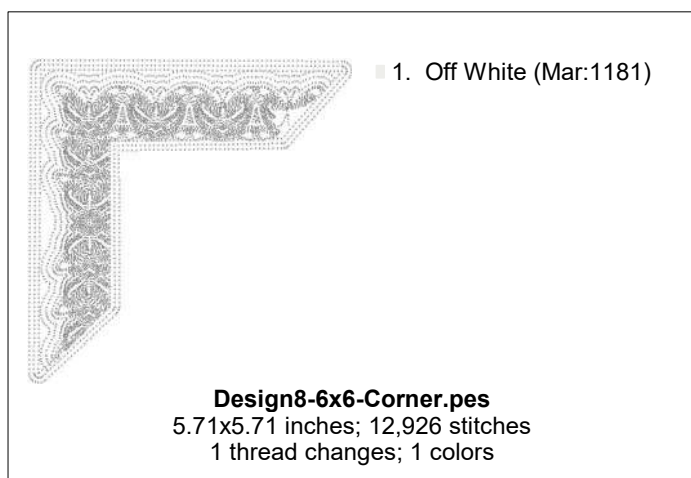
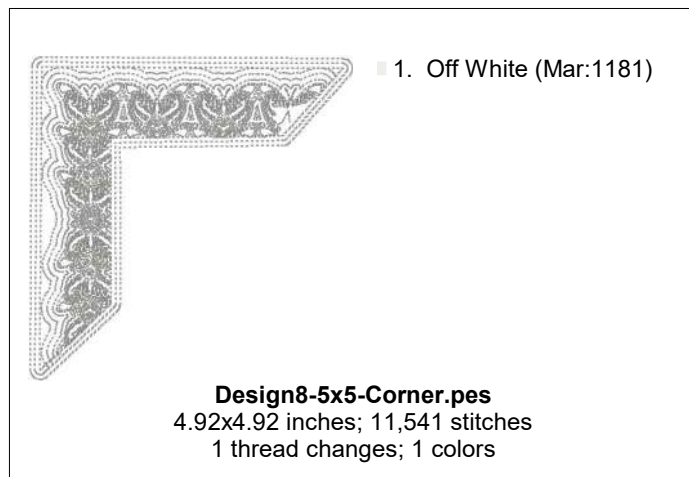
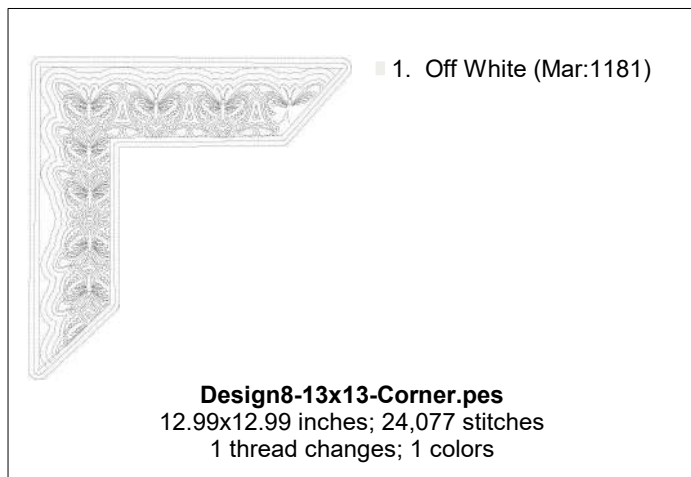

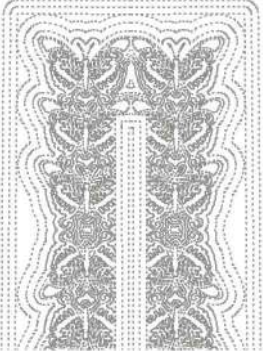

■ 1. Off White (Mar:1181)

**Design9-5x5-Border.pes**  
3.65x4.92 inches; 15,223 stitches  
1 thread changes; 1 colors

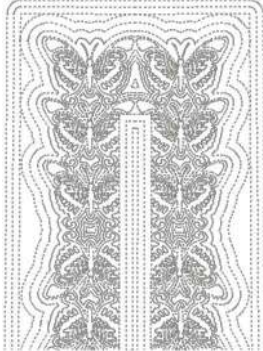

■ 1. Off White (Mar:1181)

**Design9-6x6-Border.pes**  
4.23x5.71 inches; 16,905 stitches  
1 thread changes; 1 colors

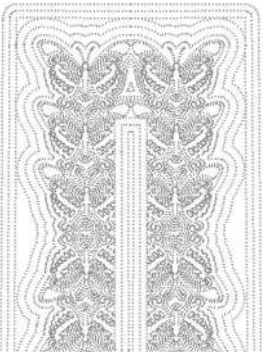

■ 1. Off White (Mar:1181)

**Design9-8x8-Border.pes**  
5.69x7.68 inches; 21,253 stitches  
1 thread changes; 1 colors

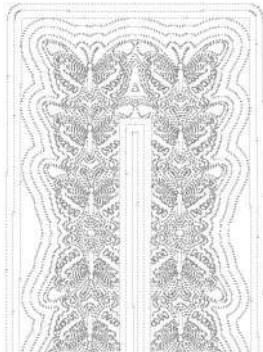

■ 1. Off White (Mar:1181)

**Design9-9x9-Border.pes**  
6.27x8.46 inches; 22,799 stitches  
1 thread changes; 1 colors